

# PANEL STOP MOULDING

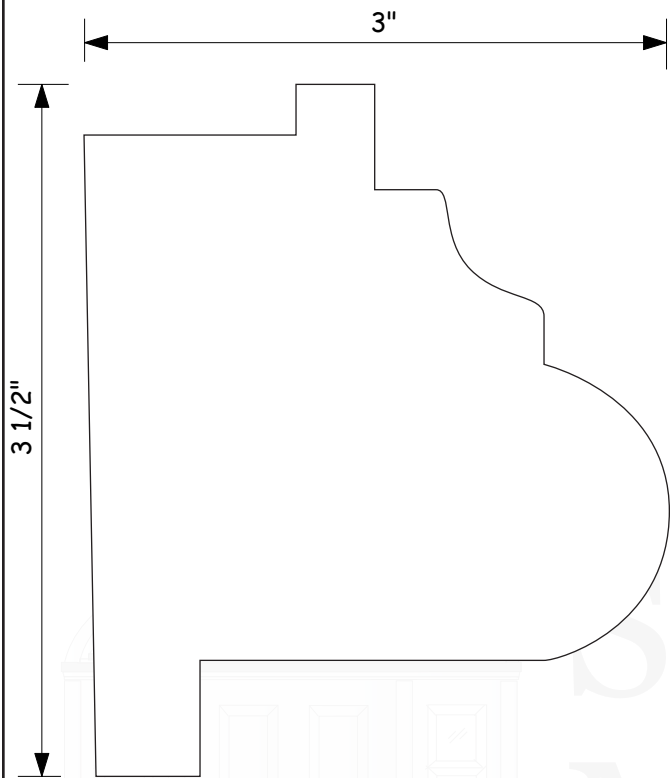

PS90001

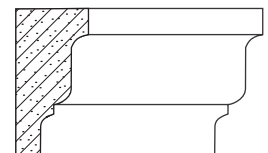
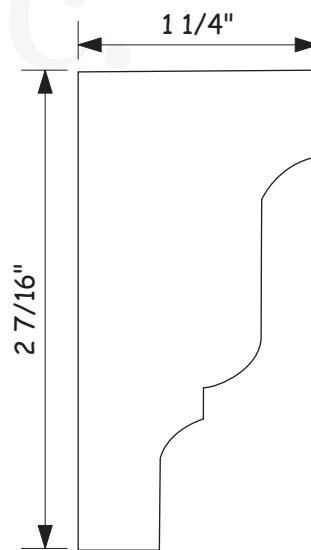
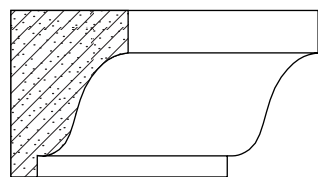
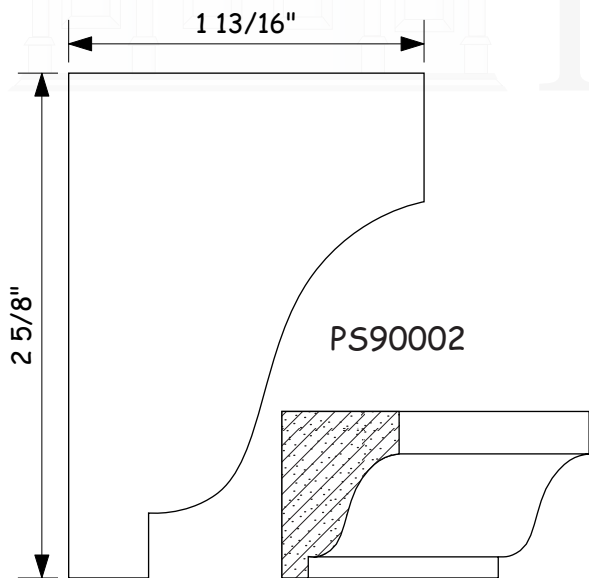
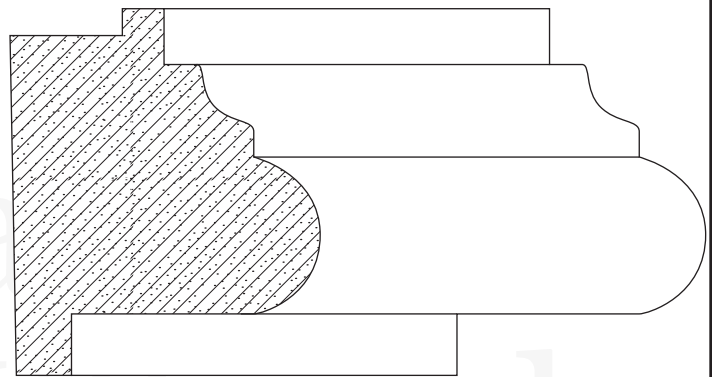

# PANEL STOP MOULDING

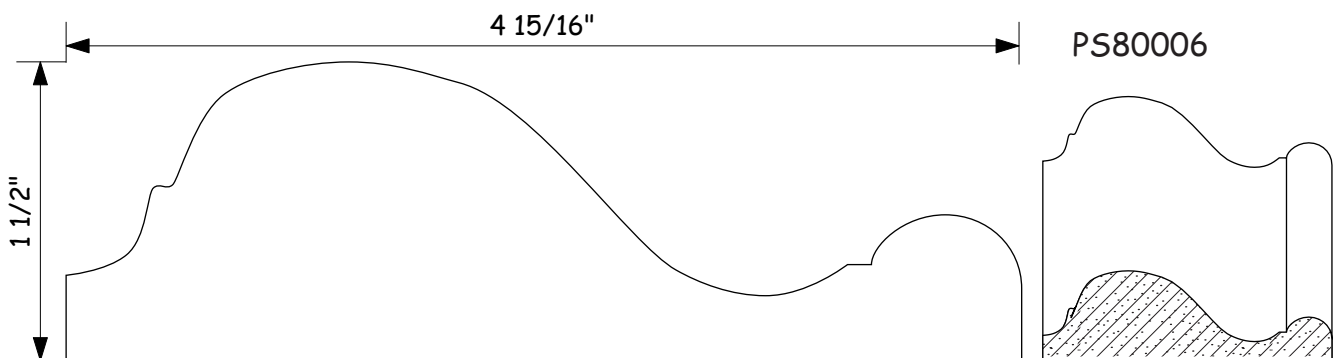
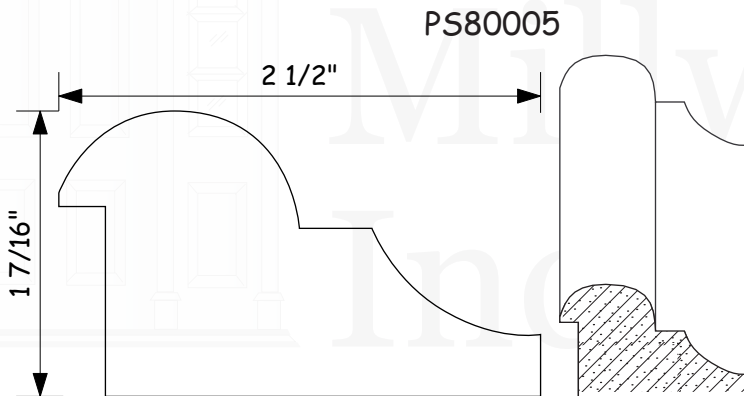
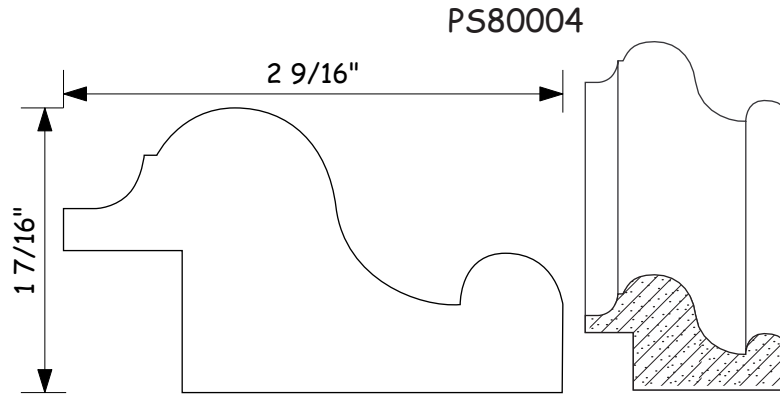

# PANEL STOP MOULDING

PS80007

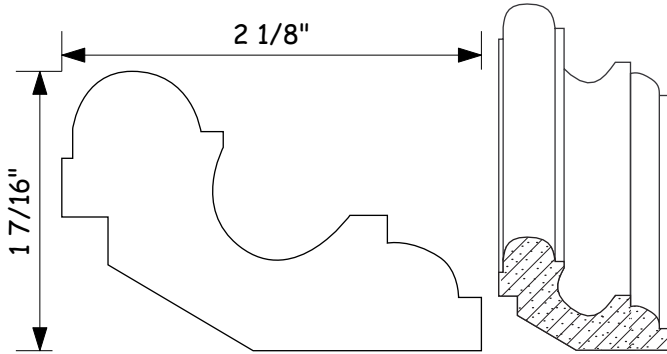

PS60008

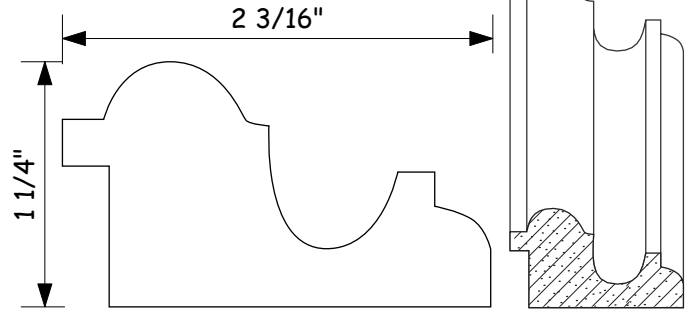

PS80009

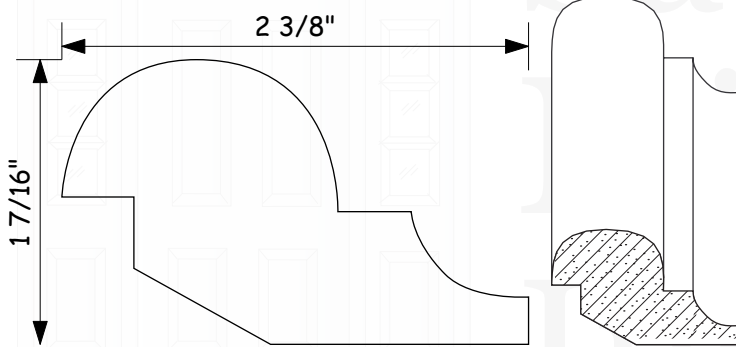

PS60010

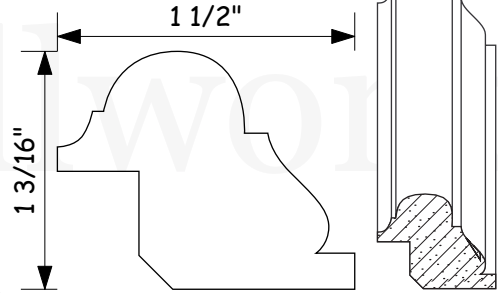

PS60011

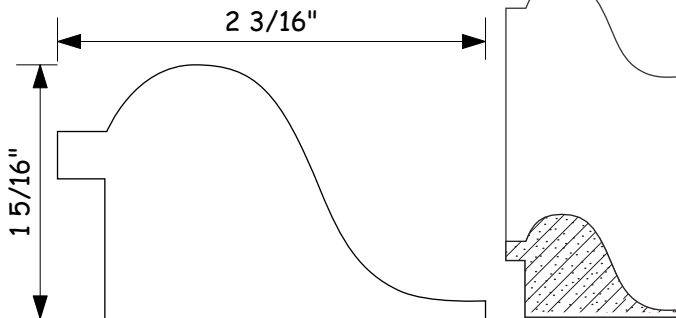

PS60012

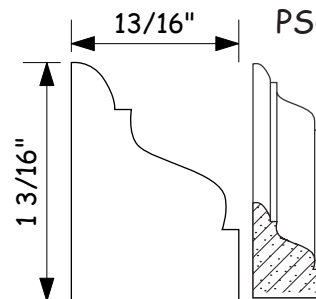

# PANEL STOP MOULDING

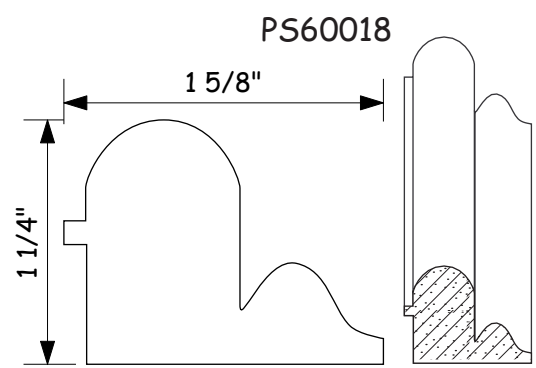
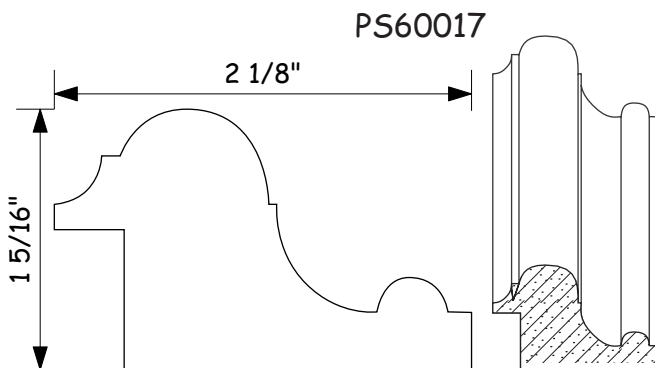
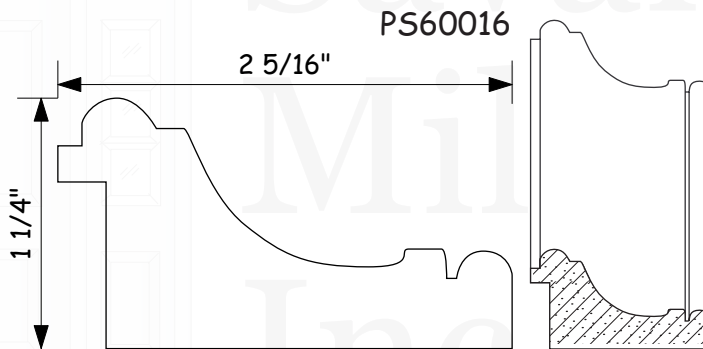
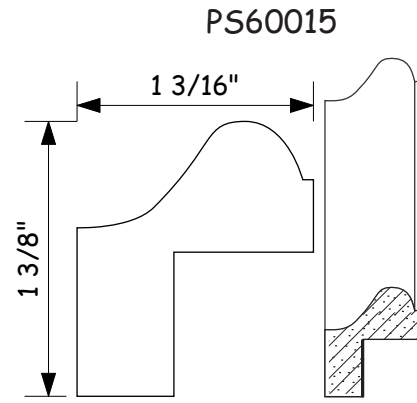
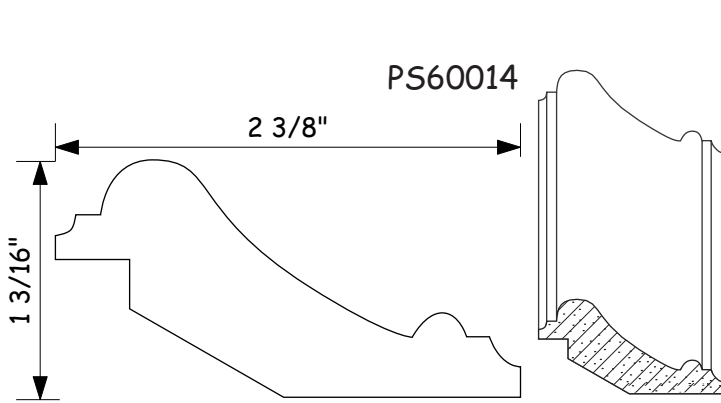

# PANEL STOP MOULDING

PS60019

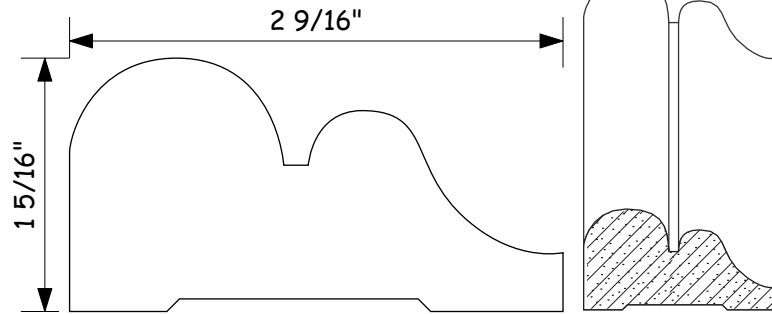

PS50021

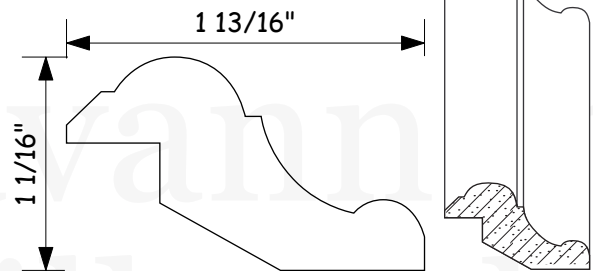

PS60020

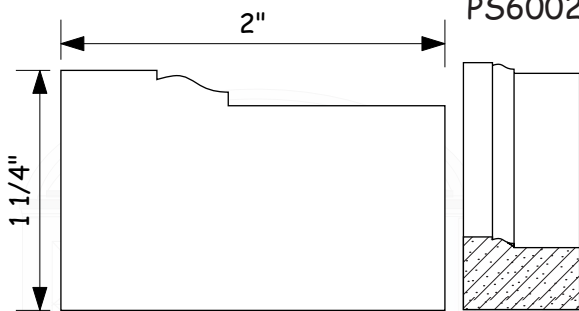

PS50022

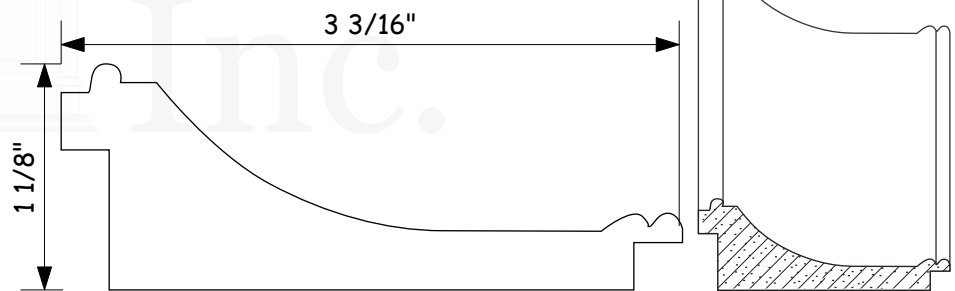

PS60023

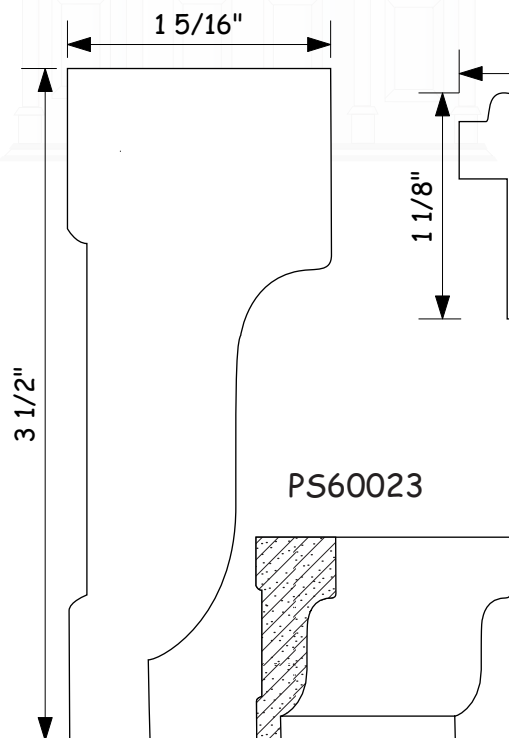

PS50024

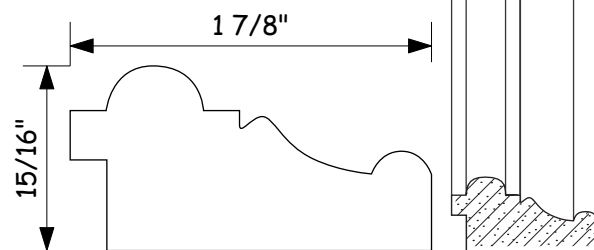

# PANEL STOP MOULDING

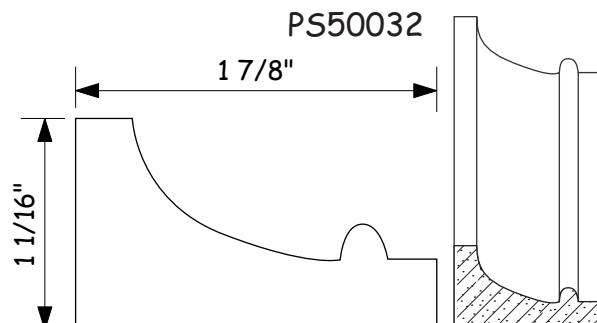
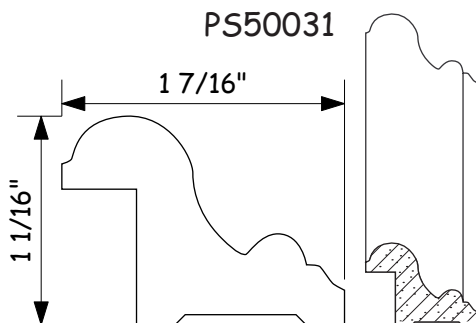
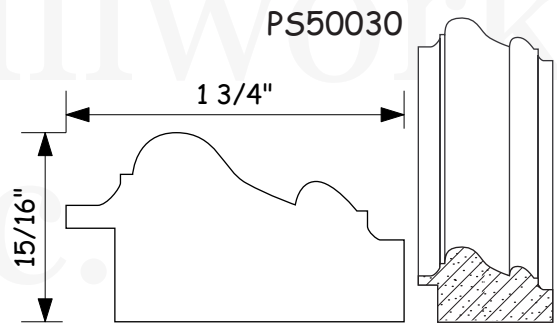
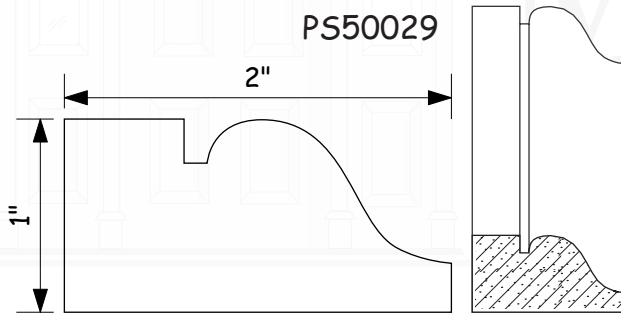
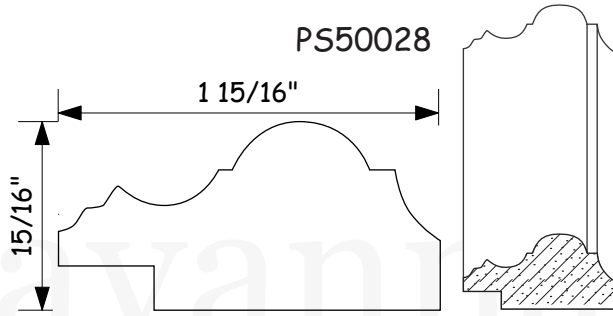
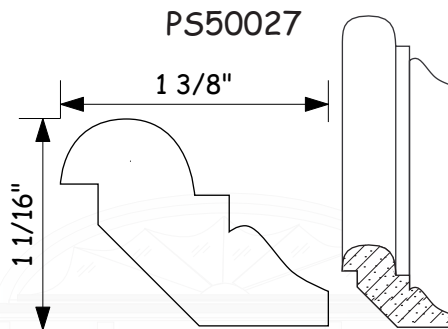
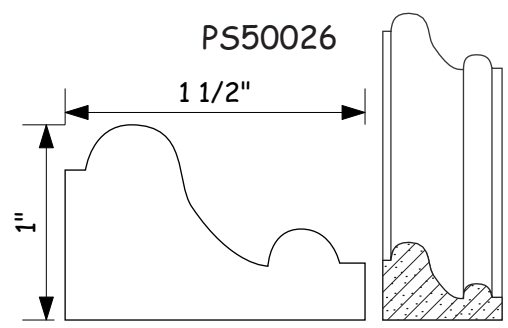
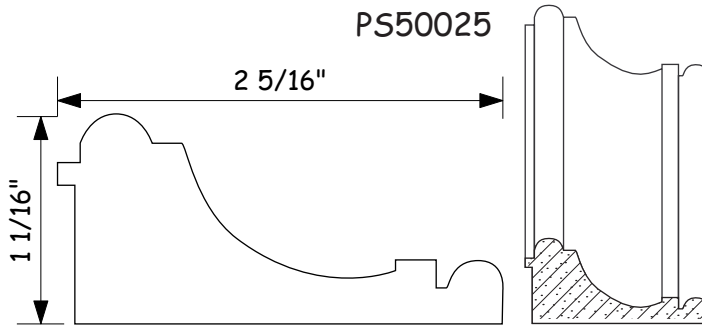

# PANEL STOP MOULDING

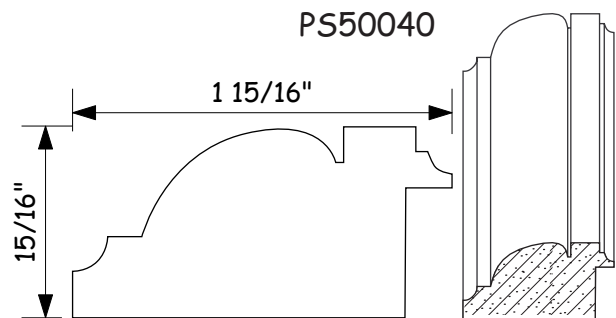
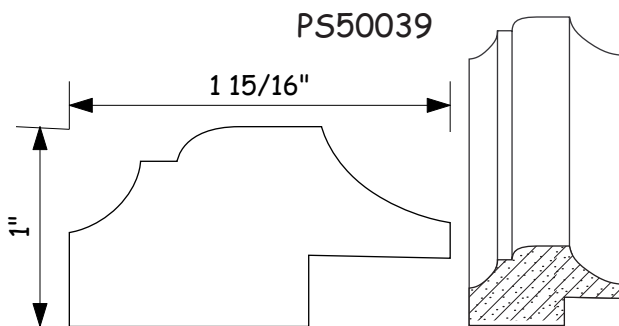
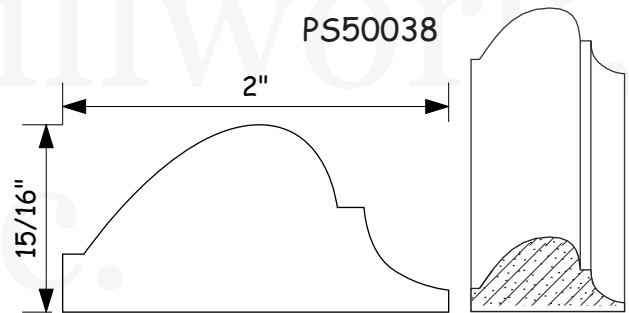
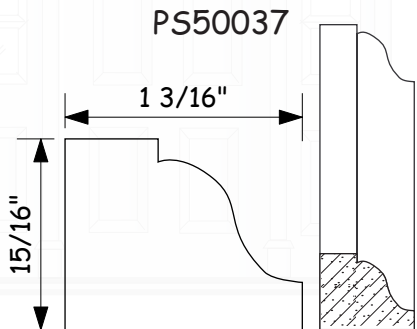
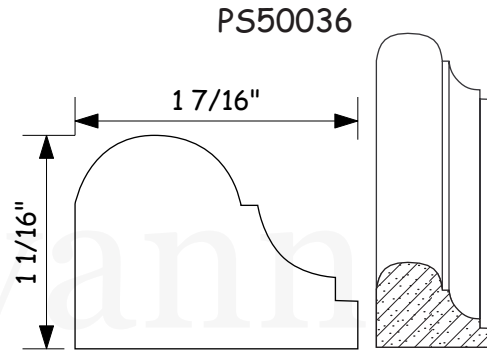
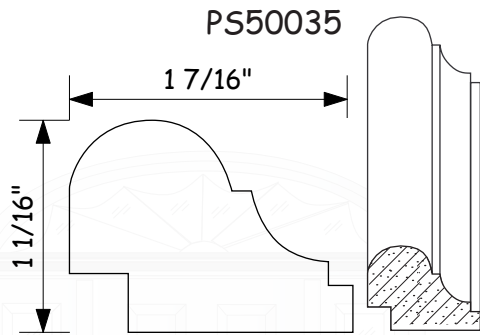
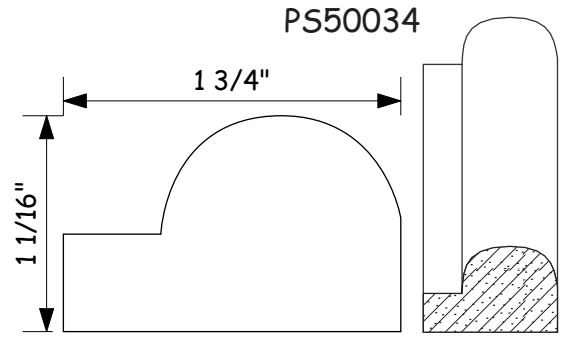
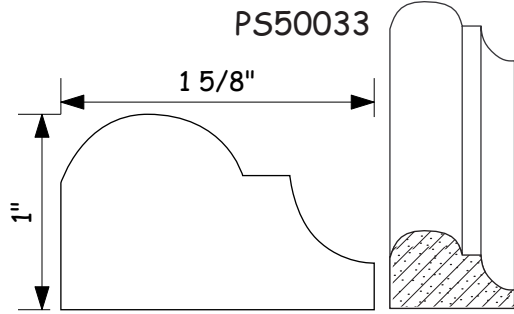

# PANEL STOP MOULDING

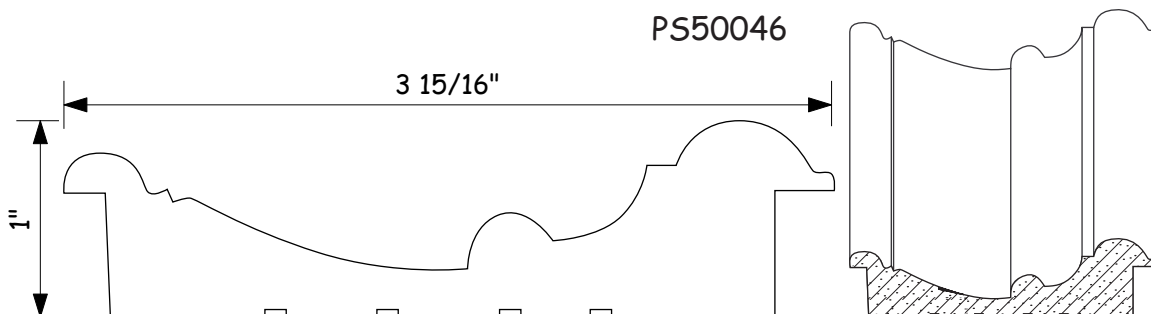
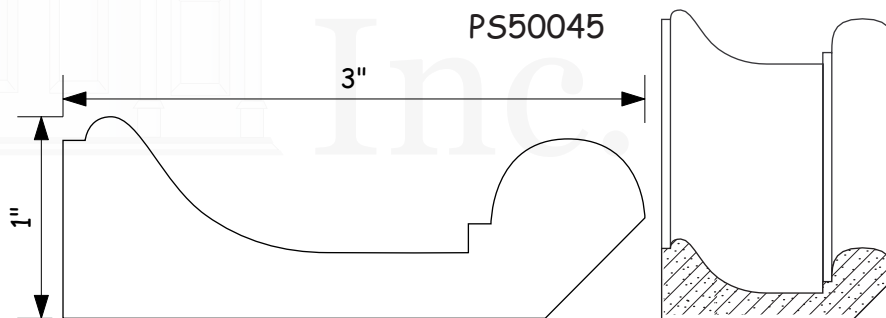
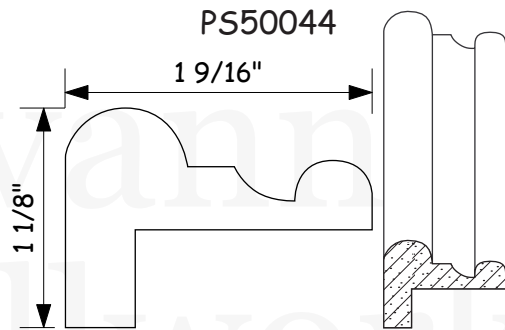
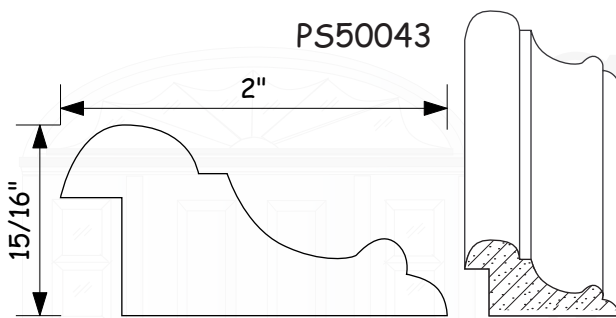
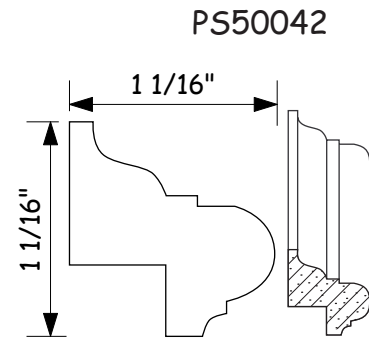
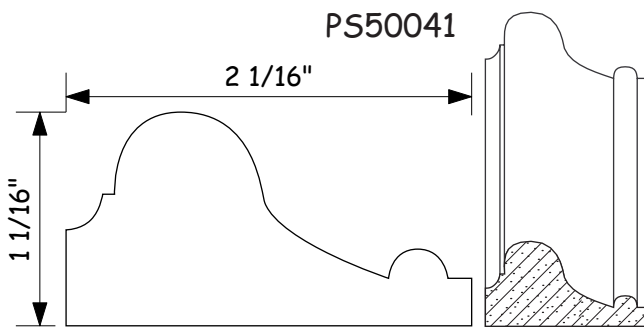

# PANEL STOP MOULDING

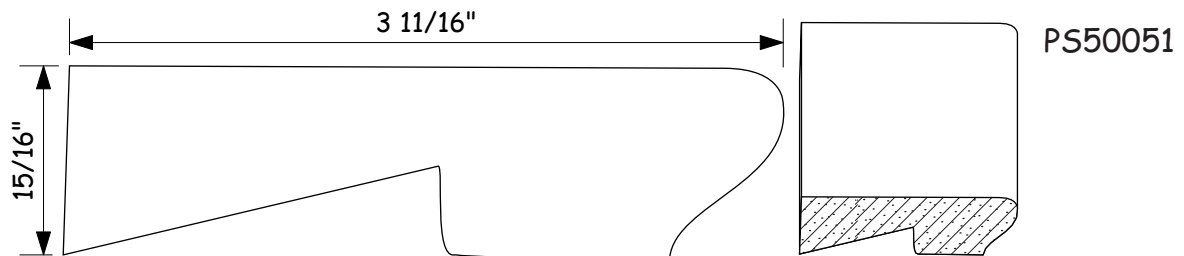
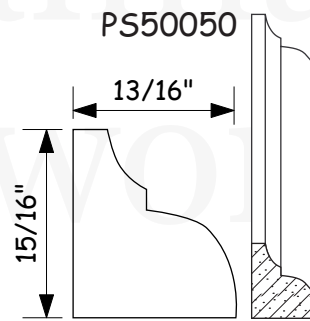
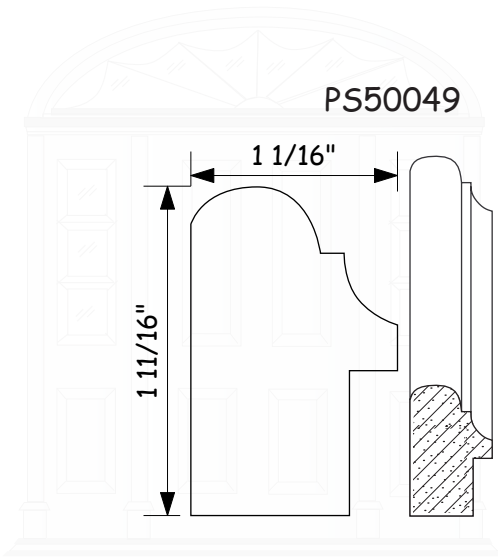
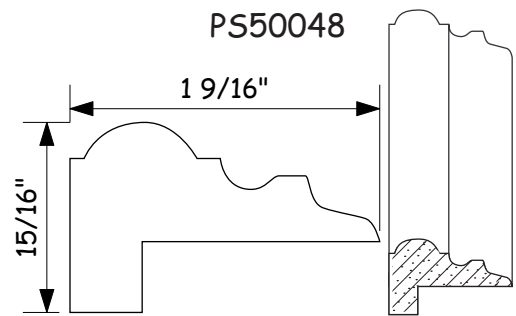
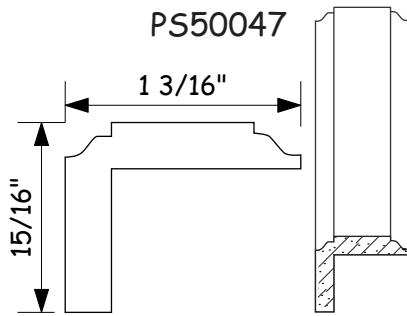

# PANEL STOP MOULDING

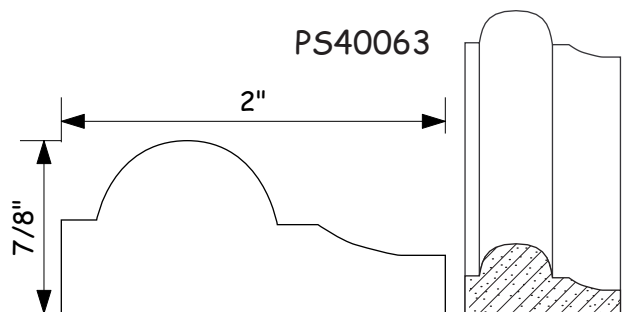
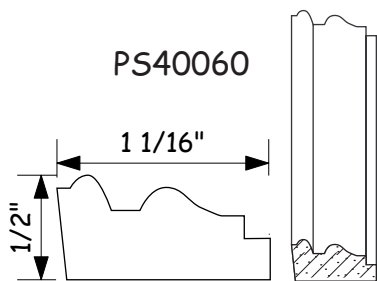
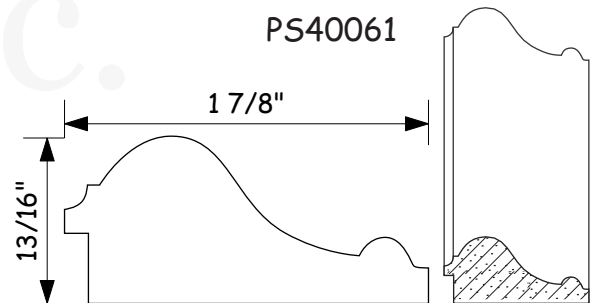
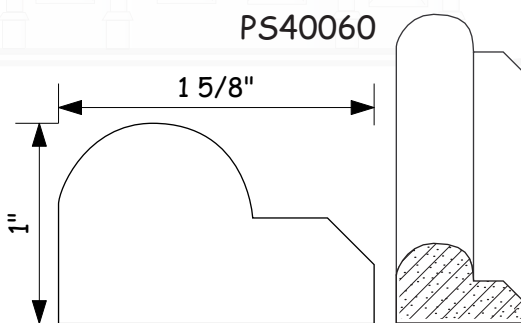
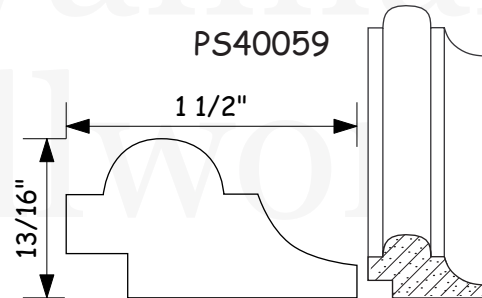
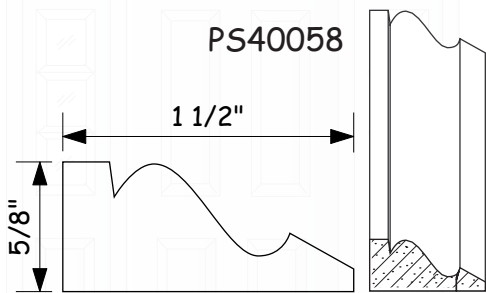
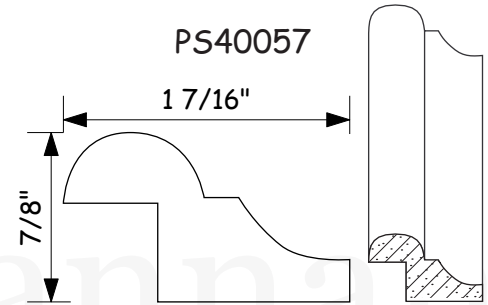
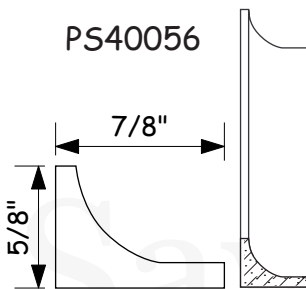
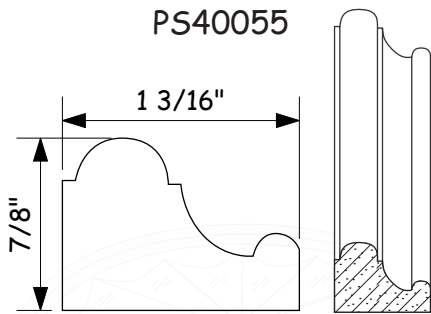
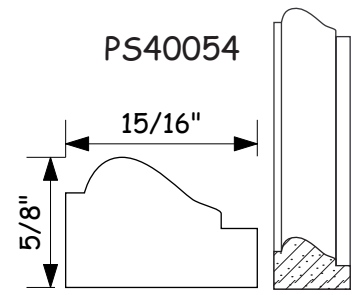
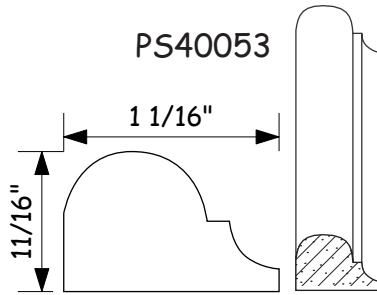
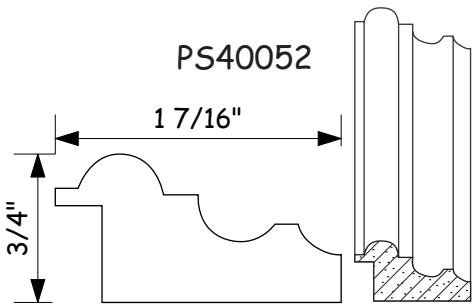

# PANEL STOP MOULDING

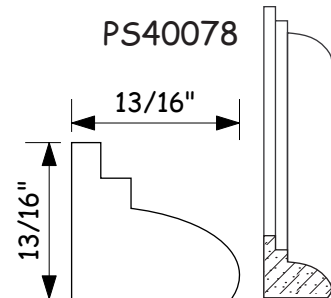
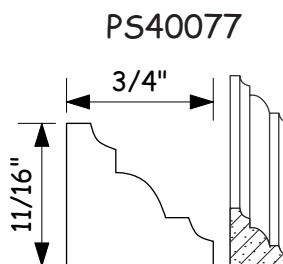
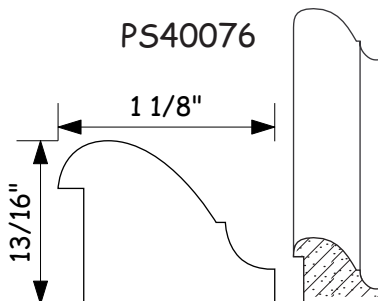
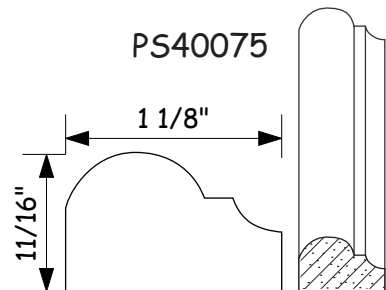
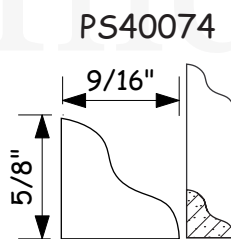
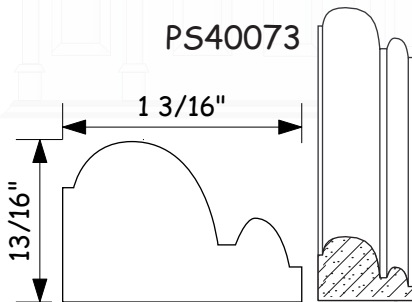
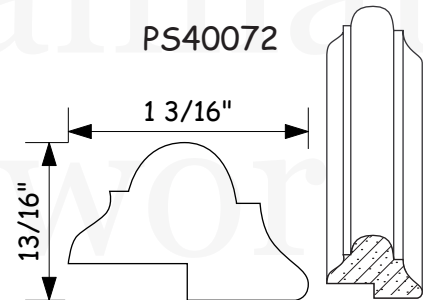
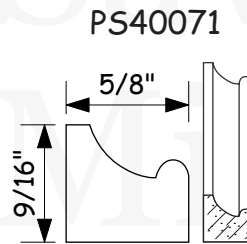
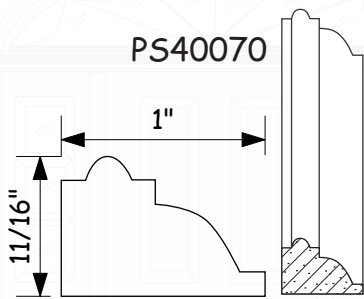
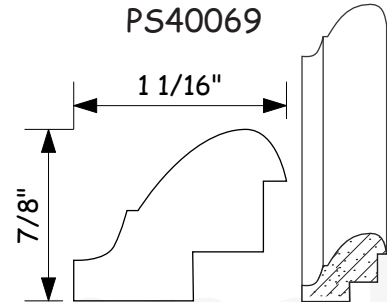
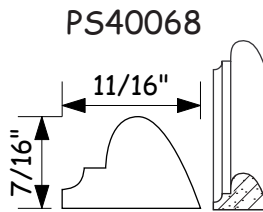
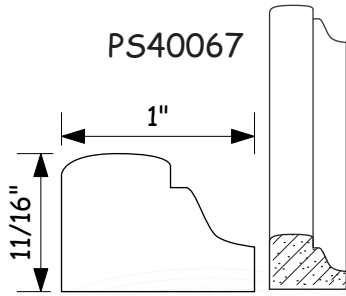
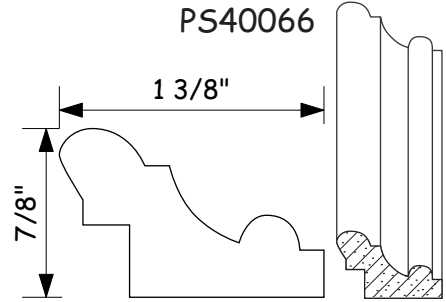
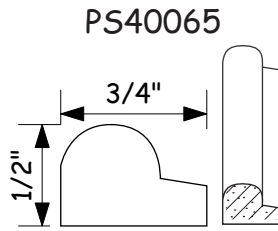
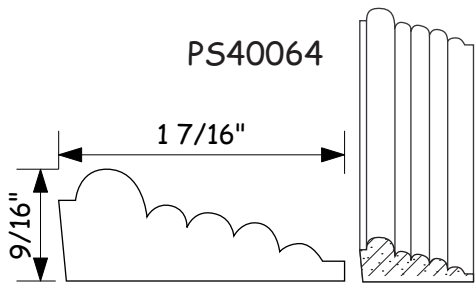

# PANEL STOP MOULDING

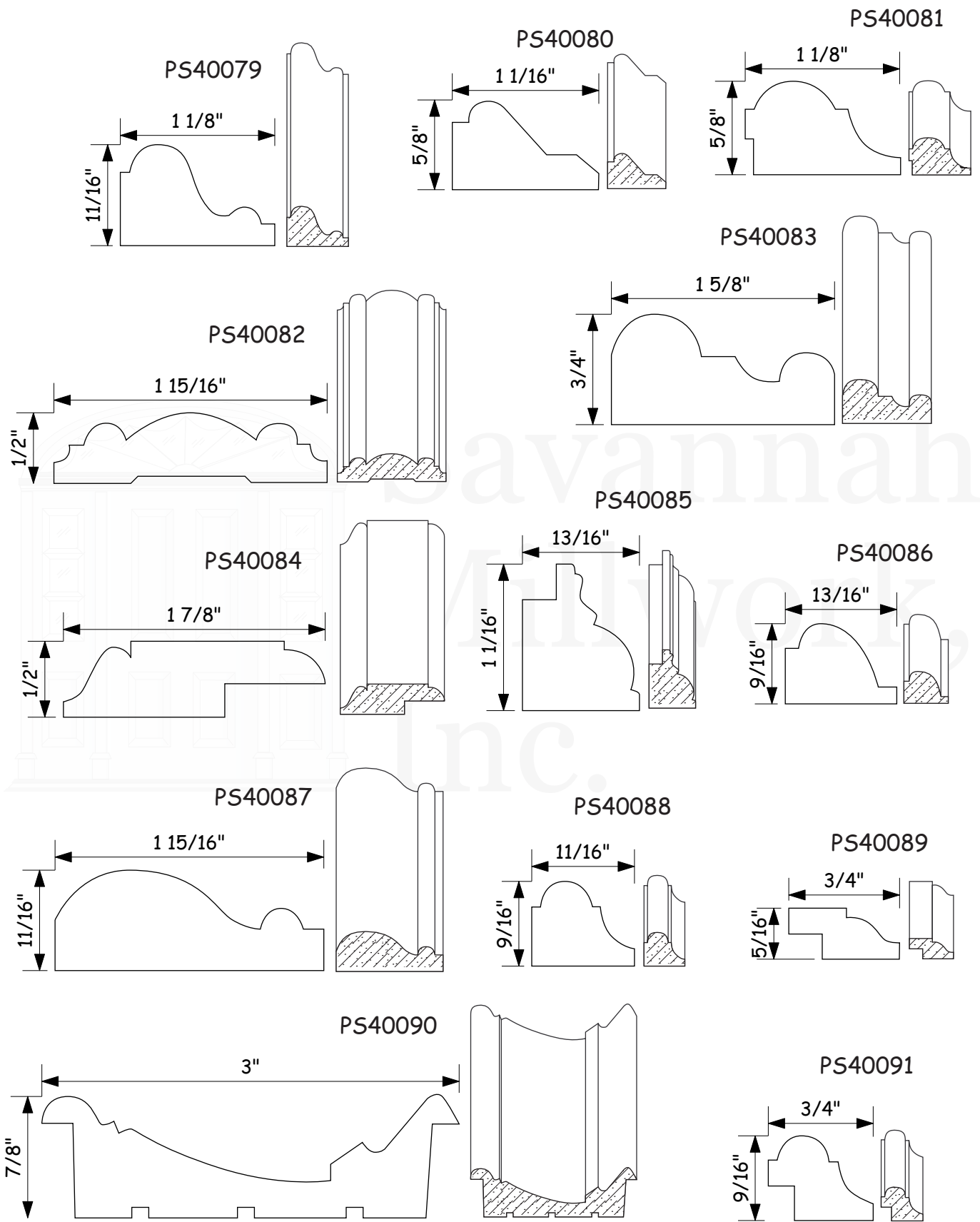

# PANEL STOP MOULDING

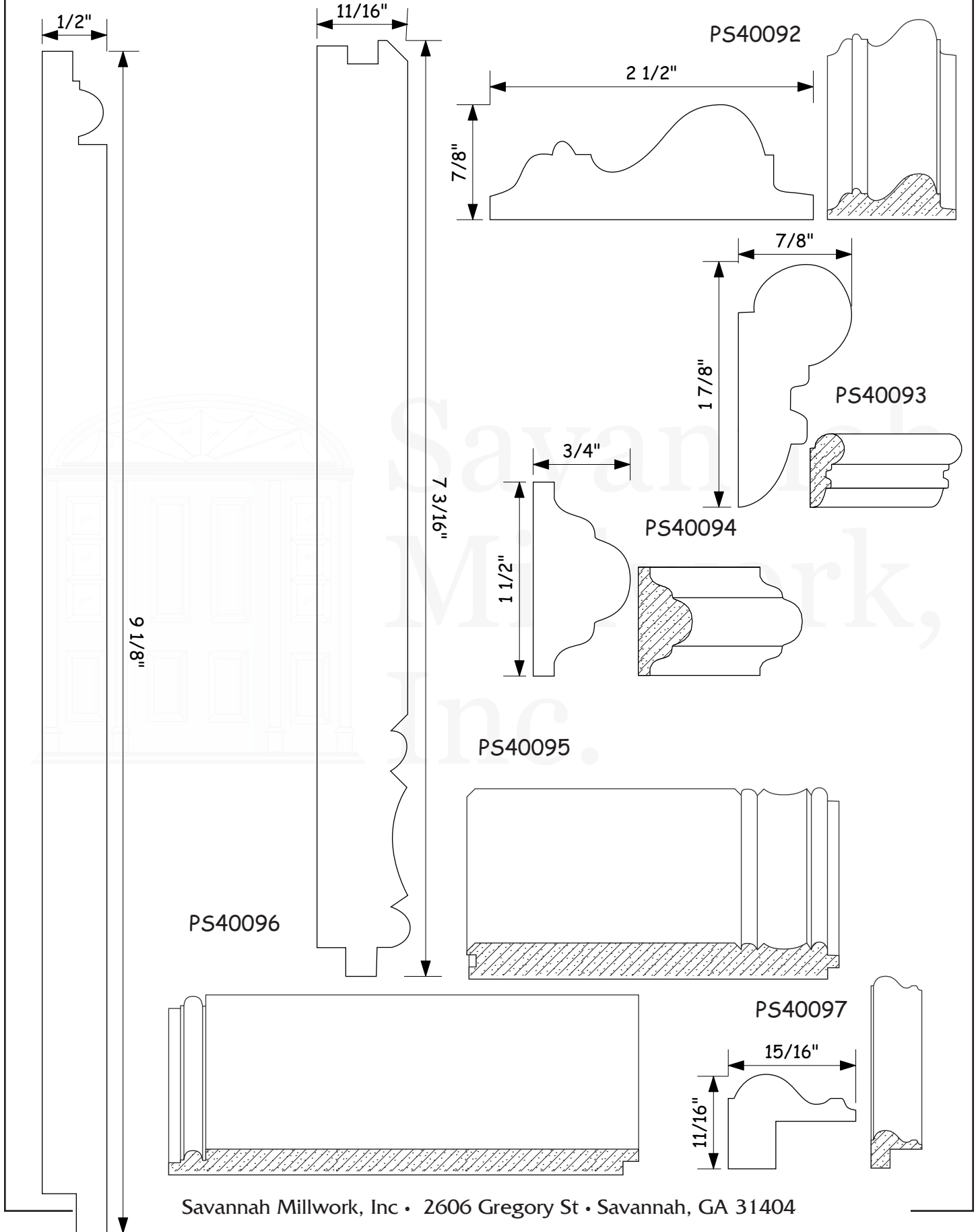

# PANEL STOP MOULDING

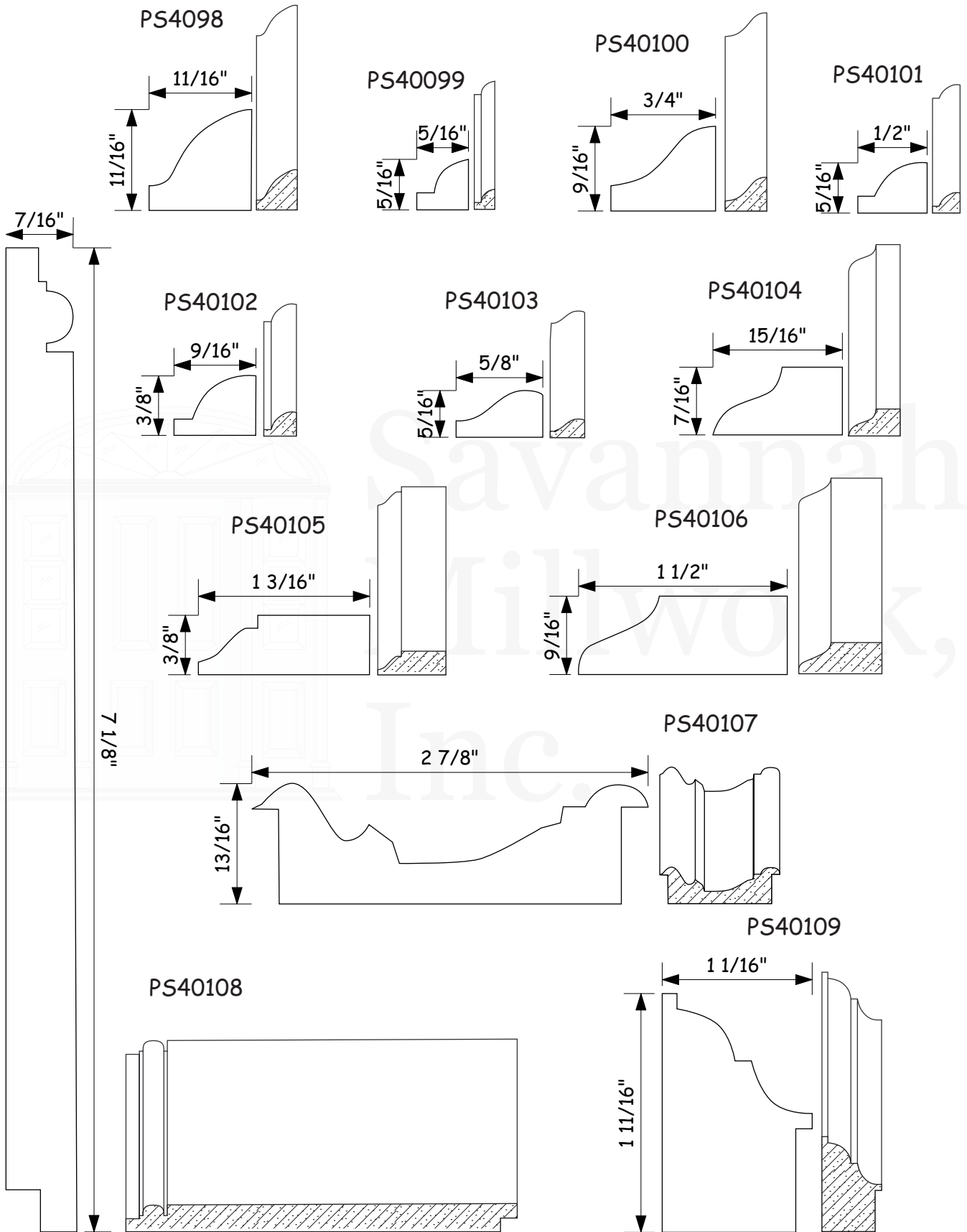

# PANEL STOP MOULDING

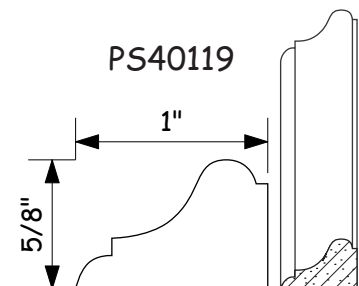
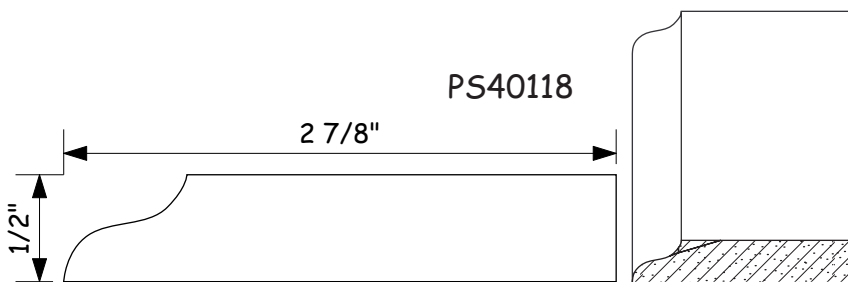
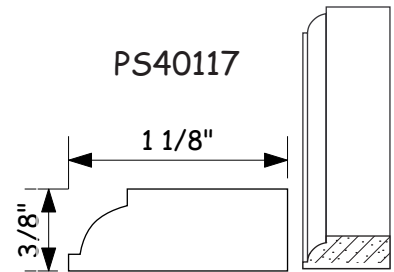
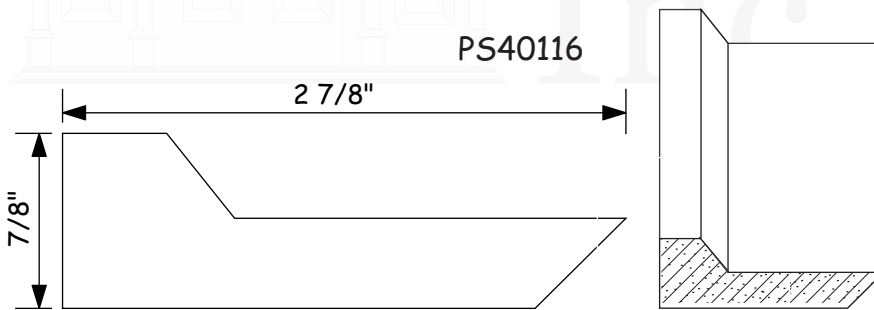
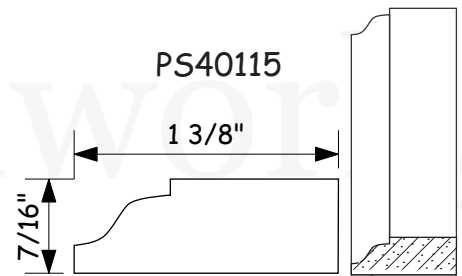
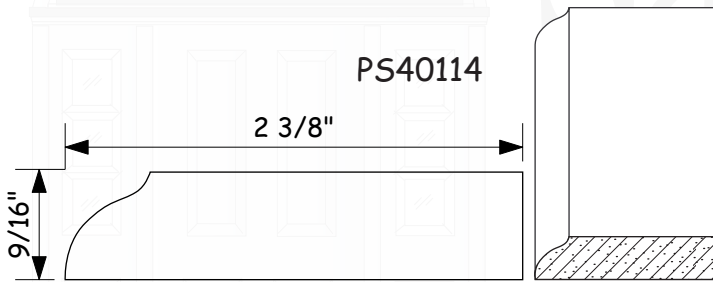
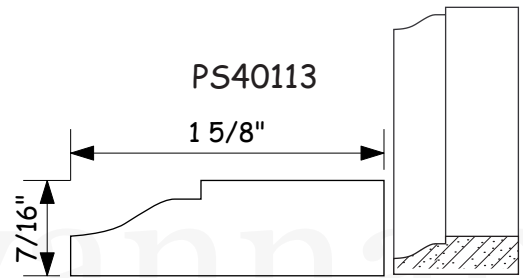
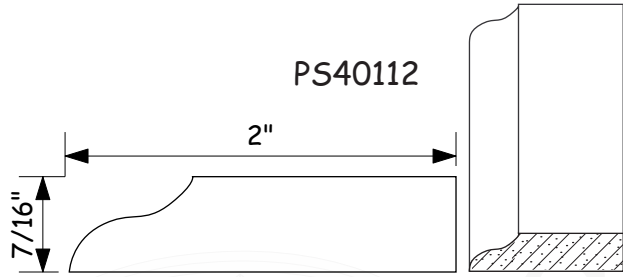
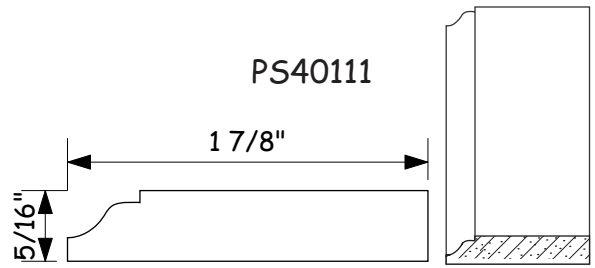
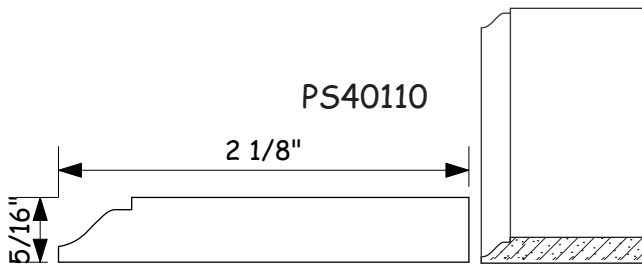

# PANEL STOP MOULDING

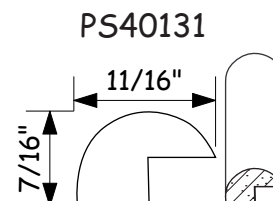
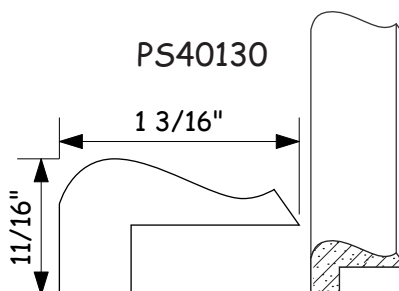
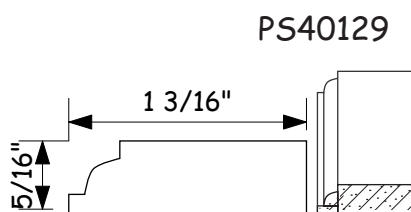
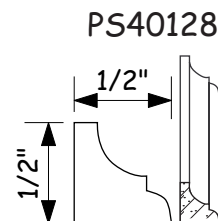
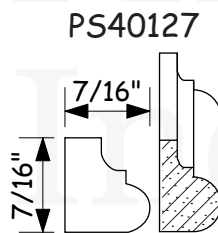
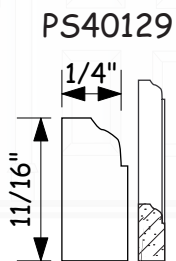
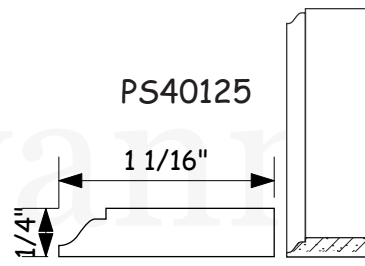
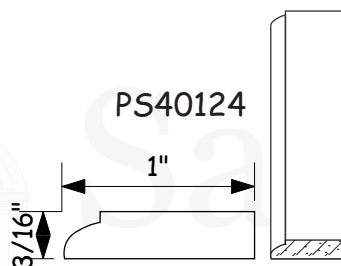
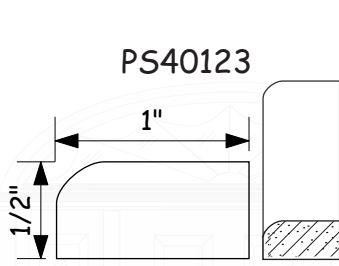
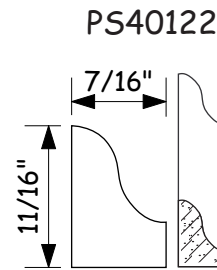
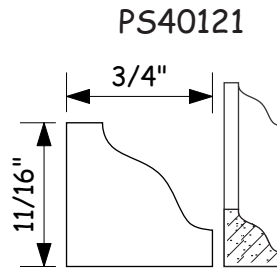
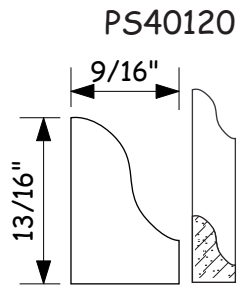

# PANEL STOP MOULDING

PS40132

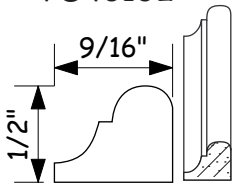

PS40133

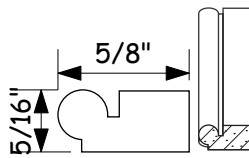

PS40134

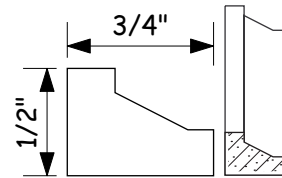

PS40135

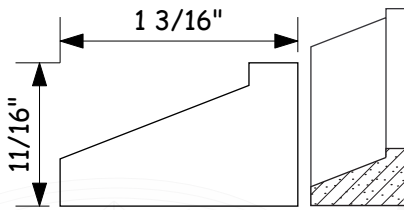

PS40136

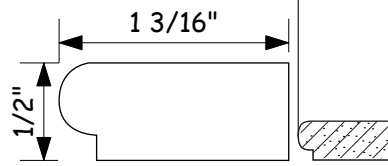

PS40137

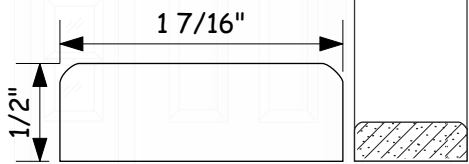

PS40138

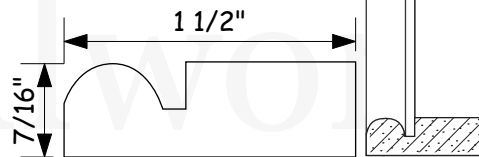

PS40139

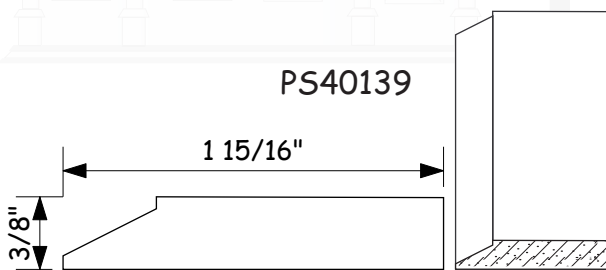

PS40140

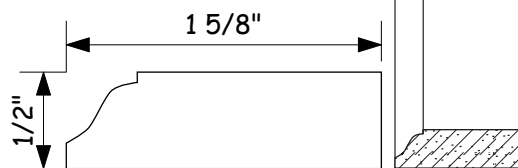

PS40141

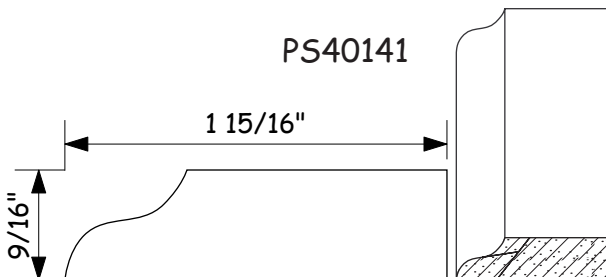

PS40142

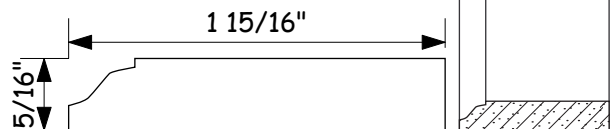

# PANEL STOP MOULDING

PS40143

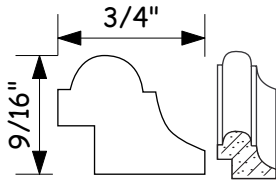

PS40144

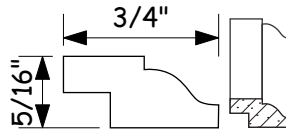

PS40145

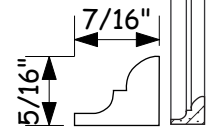

PS40146

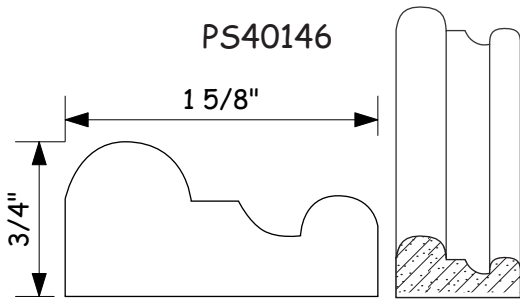

PS40147



PS40148

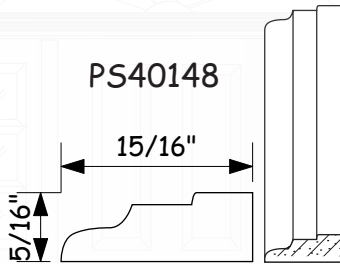

PS40149

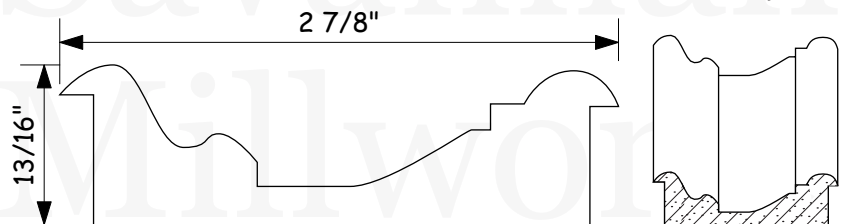

PS40150

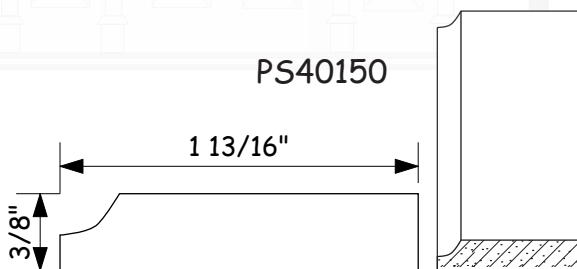

PS40151

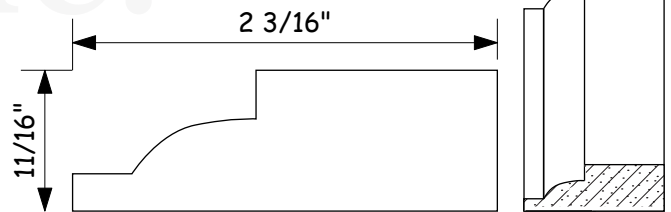

PS40152



PS40153

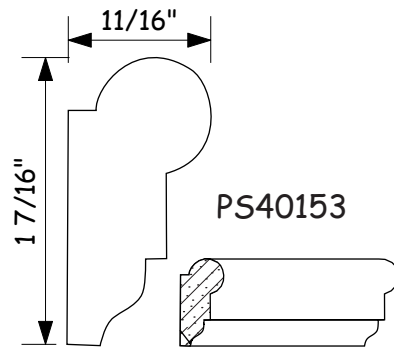

# PANEL STOP MOULDING

PS40154

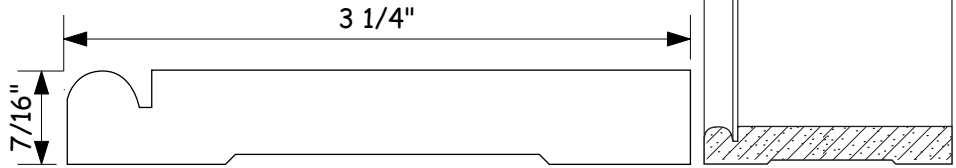

PS40155

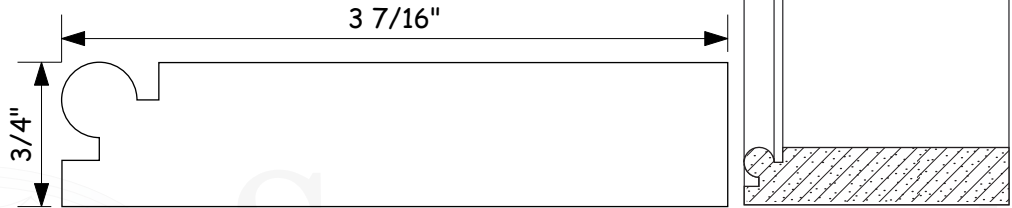

PS40156

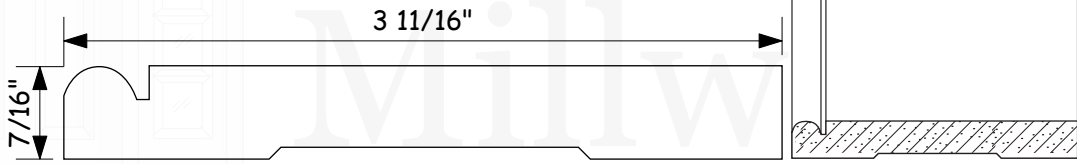

PS40157

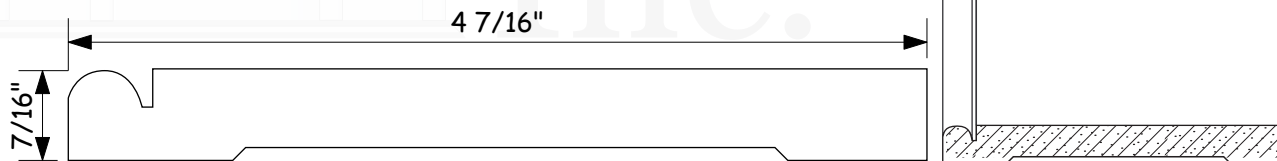

PS40158

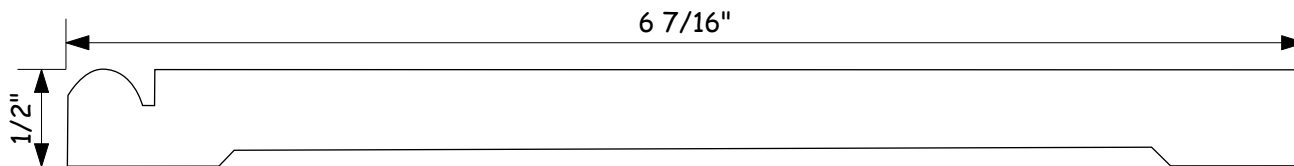

# PANEL STOP MOULDING

